

SPECIFICATIONS

S36AW

Description:	3-Way 6" vertical/horizontal, mirror-image, wall-mount/bookshelf, weather-resistant loudspeakers
Maximum Recommended Amplifier Power*:	150W
Nominal Impedance:	8 Ohms
Sensitivity (2.83V/1m):	90dB
Frequency Response (-3dB):	60Hz – 20kHz
Crossover Frequencies:	650Hz, 3000Hz
High-Frequency Transducer:	1" Pure-titanium dome, with rubber surround, shielded; Elliptical Oblate Spheroidal™ (EOS) waveguide
Midrange Transducer:	4" WeatherPlas™ (polymer-coated cellulose fiber) cone, rubber surround, shielded; Linear Field Proximity™ (LFP) bezel
Low-Frequency Transducer:	6" WeatherPlas™ (polymer-coated cellulose fiber) cone, rubber surround, SFG™ magnetic shorting rings, high-temp oversized Kapton® voice coil, HeatScape™ motor structure, cast-aluminum baskets, shielded
Baffles:	Low diffraction, IsoPower™
Enclosure:	Sealed
Network:	Straight-Line Signal Path™ (SSP)
Terminals:	All-metal, gold-plated 5-way binding posts
Dimensions (H x W x D):	10-1/4" x 14-5/8" x 5" 260mm x 371mm x 127mm
Weight:	11 lb/5kg

*The maximum recommended amplifier power rating will ensure proper system headroom to allow for occasional peaks. We do not recommend sustained operation at these maximum power levels. All features and specifications are subject to change without notice.

OWNER'S GUIDE

PRODUCT LINE: **STUDIO™ SERIES**

MODEL NUMBER: **S36AW**

DESIGN GOAL: Bring the thrill of live performance and movie sound to the outdoors by calling on JBL's professional engineering leadership.

TWEETER TYPE: Pure-titanium dome with EOS™ waveguide

WOOFER TYPE: Cast-aluminum basket with HeatScape™ motor structure

CROSSOVER NETWORK: Straight-Line Signal Path™ (SSP)

ENCLOSURE DESIGN: Sealed

PROFESSIONAL REFERENCE: Studio Monitor

JBL

**PRO SOUND
COMES HOME™**

JBL Consumer Products
250 Crossways Park Drive, Woodbury, NY 11797
8500 Balboa Boulevard, Northridge, CA 91329
800-336-4JBL (4525) (USA only)
www.jbl.com

©2001 JBL, Incorporated. JBL is a registered trademark of JBL, Incorporated.

Part No. a10449 

H A Harman International Company

THANK YOU FOR CHOOSING JBL

For more than 50 years, JBL has been involved in every aspect of music and film recording and reproduction, from live performances to the recordings you play in your home, car or office.

We're confident that the JBL loudspeakers you have chosen will provide every note of enjoyment that you expected –

and that when you think about purchasing additional audio equipment for your home, car or office, you will once again choose JBL.

Please take a moment to complete the enclosed profile card. It enables us to keep you posted on our latest advancements, and helps us to better understand

our customers and build products that meet their needs and expectations.

JBL Consumer Products

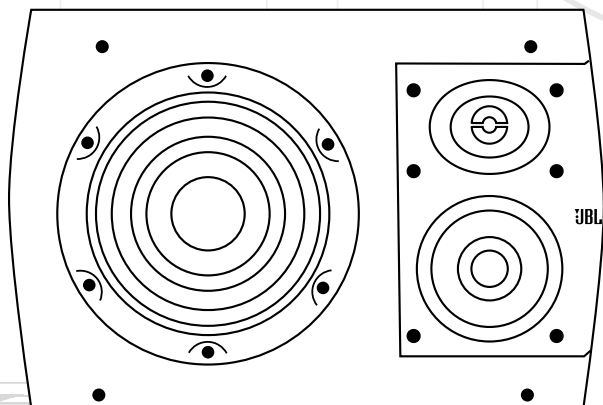

OWNER'S GUIDE

PRODUCT LINE: **STUDIO™ SERIES**

MODEL NUMBER: **S36AW**

DESIGN GOAL: Bring the thrill of live performance and movie sound to the outdoors by calling on JBL's professional engineering leadership.

TWEETER TYPE: Pure-titanium dome with EOS™ waveguide

WOOFER TYPE: Cast-aluminum basket with HeatScape™ motor structure

CROSSOVER NETWORK: Straight-Line Signal Path™ (SSP)

ENCLOSURE DESIGN: Sealed

PROFESSIONAL REFERENCE: Studio Monitor

JBL

SPEAKER PLACEMENT

Proper placement of the speakers is an important step in obtaining the most realistic soundstage possible. These recommendations are for the optimum placement of the loudspeakers. Use these placement recommendations as a guide. Slight variations will not diminish your listening pleasure.

The S36AW loudspeakers are weather-resistant and are specifically designed for outdoor use, such as in a patio area. As noted below, we recommend mounting the speakers under an overhang, such as roof eaves, for added protection. The S36AW speakers, because they are resistant to moisture, are also

appropriate for mounting in a bathroom, although not inside a bathtub or shower stall.

Although these loudspeakers are designed as a mirrored pair, the decision as to which one is left or right will depend on the amount of space left between them.

A wider stereo image is presented with the tweeter/midrange array outboard, and a tighter image is presented with the array inboard.

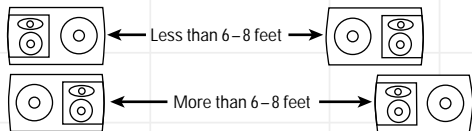

WALL-MOUNTING

Do not attempt to mount these speakers on a ceiling, on the underside of roof eaves or in a shower stall.

The S36AW loudspeakers may be positioned on the wall either horizontally or vertically. The grille logo on each speaker may be rotated depending on how the speaker is positioned. Gently pull the logo away from the grille slightly, rotate it to the desired position, and let go. The logo will snap back into place.

When mounted vertically, the tweeter array may be positioned either up or down, depending on the height of the placement. If the speakers will be above ear level, the tweeter array should be positioned down, preferably no more than two feet above ear level. If the speakers will be mounted very low, it may be best to position the tweeter array upward so that it will be no more than two feet below ear level.

The S36AW enclosures are specially designed to angle the speakers toward the listener when mounted flush against the wall.

When mounting the speakers outdoors, we recommend that

you place them under an overhang, such as roof eaves, for added protection, and that you use two of the supplied special angle-mount screws per speaker, which angle the speakers downward at a greater-than-usual angle, facilitating water drainage.

NOTE: When using the enclosed angle-mount screws, always use the top two screw locations appropriate for the specific mounting orientation of your S36AW. Referring to the enclosed installation template, screw locations (1) and (2) are to be used when mounting the S36AW horizontally so that these locations are on top. To mount the loudspeakers vertically, use locations (2) and (4) or locations (1) and (3), depending on the mounting orientation. Do not mount the S36AW upside down (with screw locations (3) and (4) on top) because it won't be able to lock onto the screw heads. Remember that the JBL logo on the tweeter/mid faceplate can be rotated with choice of speaker position (vertical or horizontal).

At least one screw per speaker should be installed in a wooden wall stud. Select an appropriate wall anchor for the other screw. If the special angle-mount screws are not being used, size 10 screws of at least 1-1/2" in length are recommended. If the screws are used in drywall or other surfaces incapable of holding the screw by itself, selection of proper anchors is essential. The customer is solely responsible for proper selection and installation of screws, anchors and other installation hardware. Further installation details are included on the installation template.

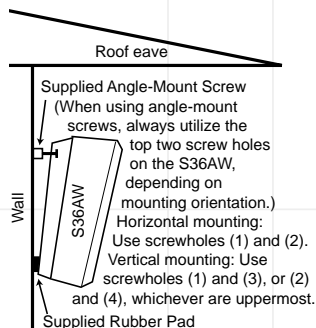

Installation of Self-Adhesive Rubber Pads: If the S36AW is to be placed on a surface (such as a table top or shelf) rather than being wall-mounted, the enclosed self-adhesive rubber pads are to be attached to the bottom of the speaker cabinet in their designated recessed locations. If the S36AW is to be wall-mounted, then the four self-adhesive rubber pads should be attached to the back

of the speaker, as shown in the bottom right diagram. When angle-mounting the S36AW, only two of the rubber pads are required, and they need to be installed on the back of the loudspeaker, near the lower edge, so that they are located between the S36AW back and the mounting surface. Please see the enclosed installation template for more details.

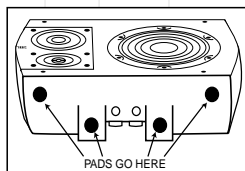

For tabletop or shelf placement

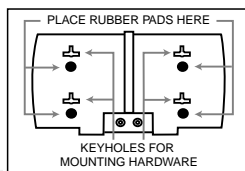

For wall-mounting

SPEAKER CONNECTIONS

CONNECTION TIPS

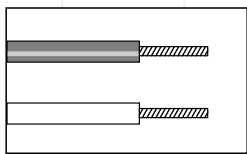

Speakers and electronics terminals have corresponding (+) and (-) terminals. It is

important to connect both speakers identically: (+) on the speaker to (+) on the amplifier and (-) on the speaker to (-) on the amplifier. Wiring "out of phase" results in thin sound, weak bass and a poor stereo image. With the advent of multichannel surround sound systems, connecting all of the speakers in your system with the correct polarity remains

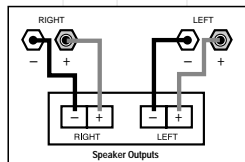

equally important in order to preserve the proper ambience and directionality of the program material.

TROUBLESHOOTING

If there is no sound from any of the speakers:

- Check that receiver/ amplifier is on and that a source is playing.
- Review proper operation of your receiver/ amplifier.
- Make sure all wires are connected. Make sure none of the speaker wires are frayed, cut or punctured.

If the system plays at low volumes but shuts off as volume is increased:

- Check all wires and connections between receiver/ amplifier and speakers.

- Make sure all wires are connected. Make sure none of the speaker wires are frayed, cut or punctured.
- If more than one pair of main speakers is being used, check the minimum impedance requirements of your receiver/ amplifier.

If there is no sound coming from one speaker:

- Check the "Balance" control on your receiver/ amplifier.
- Check all wires and connections between receiver/ amplifier and speakers.

- Make sure all wires are connected. Make sure none of the speaker wires are frayed, cut or punctured.

Declaration of Conformity



We, Harman Consumer International
2, route de Tours
72500 Chateaubriant-Loir
France

declare in own responsibility, that the loudspeaker described in this owner's manual is in compliance with technical standards:

EN 50081-1:1992
EN 50082-1:1992

Luc E. Godard
Harman Consumer International
Chateaubriant-Loir, France, 30/01